

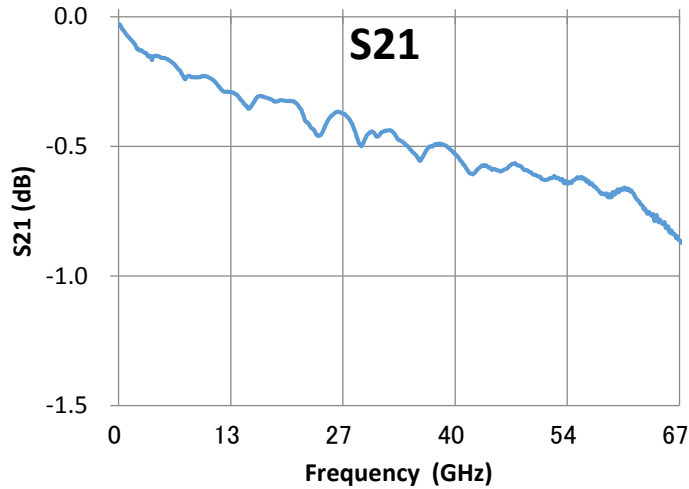

RF Probe Model: TP67A Series

Typical Insertion Loss (GSG-150um pitch)



Typical Return Loss (GSG-150um pitch)

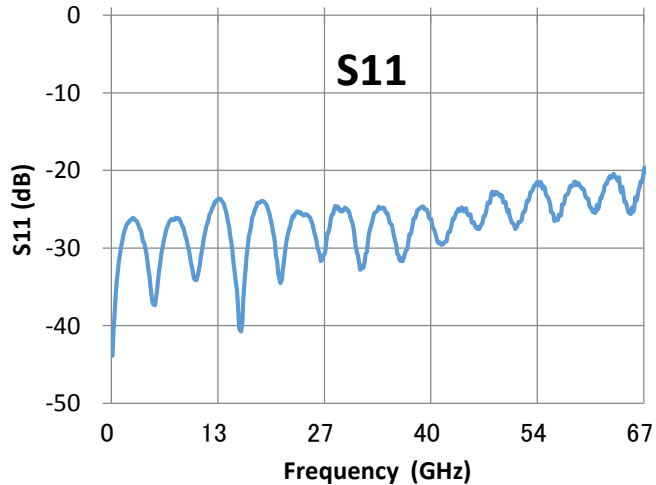

Electric Performance

Characteristic impedance	50 ohm
Frequency range	DC to 67GHz
Insertion loss (Typ. GSG-150μm)	-0.8dB
Return Loss (Typ. GSG-150μm)	-18dB
DC voltage	100V
DC current	1A
RF Power @ 10GHz max	5W
Contact resistance on Au	0.05 ohm

Mechanical Performance

Connector	1.85mm(J)
Available Pitch	50 to 1000μm (25um step)
Available Configuration	GS , SG, GSG (Recommended maximum GS(SG) Pitch: 250um)
Probe Material	Nickel Alloy
Body Material	Aluminum Alloy
Contact pressure @2mil Over travel	20g
Contact Cycle (Auto Probe Mode: OD 1mil)	1M
XY position error	Max 10um
Planarity error	Max 10um
Scribing mark (Width)	30um

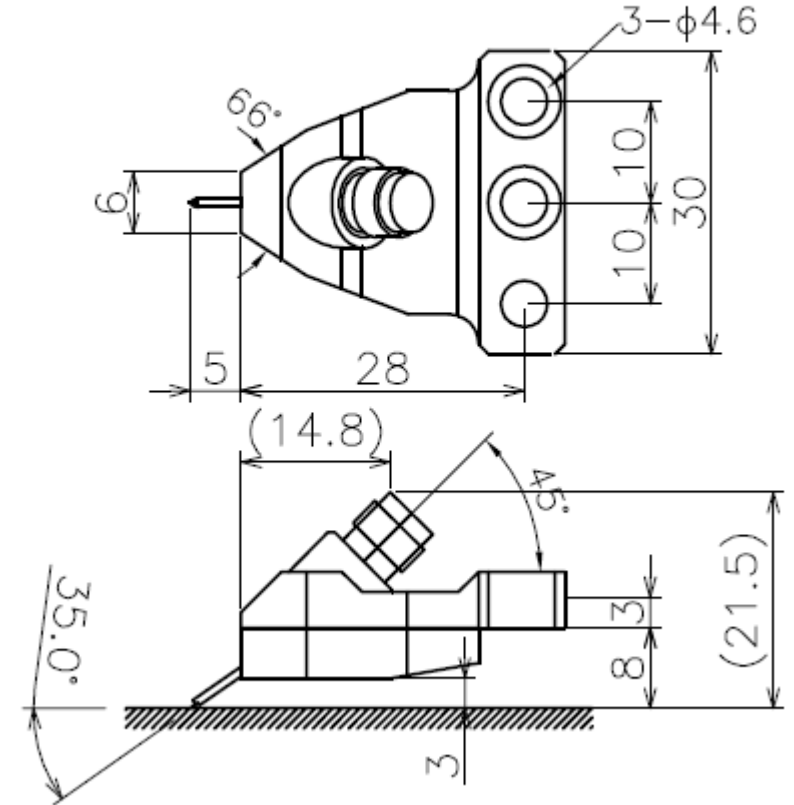

Unit: mm
Tolerance: +/-0.25